

## HISTORIC AND DESIGN REVIEW COMMISSION

March 20, 2019

**HDRC CASE NO:** 2019-115  
**COMMON NAME:** River level bounded by E Commerce, E Market, S Alamo and Bowie  
**ADDRESS:** 850 E COMMERCE ST  
889 E MARKET ST  
802 RIVERWALK  
805 E RIVER WALK  
**LEGAL DESCRIPTION:** NCB 13812 W IRR PT OF PUBLIC WATERWAY ROW  
NCB 13812 E IRR 306.04 FT OF PUBLIC WATERWAY ROW  
**ZONING:** D, D,UZROW, RIO-3  
**CITY COUNCIL DIST.:** 1  
**APPLICANT:** Rebecca Johnson/City of San Antonio Department of Arts & Culture  
**OWNER:** City of San Antonio Department of Arts & Culture  
**TYPE OF WORK:** Construction of the River Walk Public Art Garden  
**APPLICATION RECEIVED:** March 01, 2019  
**60-DAY REVIEW:** April 30, 2019  
**CASE MANAGER:** Edward Hall

### REQUEST:

The applicant is requesting a Certificate of Appropriateness for the approval of a master plan for the River Walk Public Art Garden. The Public Art Garden is located at both the street and river levels on the City owned block bounded by E Commerce, E Market, S Alamo and Bowie Streets. The proposed master plan includes three major focuses: 1) site improvements; 2) an innovative program of permanent and temporary art installations; and 3) a site signage package.

Within this application, the applicant has proposed to relocate the Samuel Gompers statue to storage. Plans for the statue's relocation have not been determined at this time.

### APPLICABLE CITATIONS:

*Unified Development Code – Section 35-640 – Public Property and Rights-of-Way*

- (a) Public Property. Generally, the historic and design review commission will consider applications for actions affecting the exterior of public properties except in the case of building interiors that are the sites of major public assemblies or public lobbies. The historic and design review commission will also consider applications for actions affecting public properties such as city parks, open spaces, plazas, parking lots, signs and appurtenances.
- (b) Public Rights-of-Way. Generally, the historic and design review commission will consider applications for actions affecting public rights-of-way whose construction or reconstruction exceeds in quality of design or materials standards of the design manual of the public works department.

*Unified Development Code – Section 35-646 – Construction in Public Rights-of-Ways*

Sec. 35-646. - Construction in Public Rights-of-Way.

(a) General Provisions. All construction in the public right-of-way shall conform to all city codes. In considering an application, the historic and design review commission shall be guided by the following:

- (1) Sidewalk Zones. Pedestrian movement should be pleasant, allowing for store browsing, comfortable transit waiting and easy accessibility for disabled people. Where possible, sidewalks should be at least five (5) feet in width. Existing sidewalks should not be narrowed when replaced.
- (2) Sidewalk Paving and Surfaces. Materials should complement stylistic differences of individual buildings, particularly when related to historic buildings.
  - A. Materials. Materials should be chosen for beauty, strength, longevity, easy maintenance and traction when dry or wet.

B. Color and Texture. To ensure the safety of pedestrians, all changes in surfaces should be defined by contrasting color, texture or materials.

(3) Street Features and Arrangements. Historic districts and the downtown, as well as other distinct areas of the city have diverse character and any street furniture selected for these areas should complement these differences. In addition, the clustering of street furniture in one (1) place is recommended. Trash receptacles, seating, telephones and other street furniture should be grouped together.

A. Circulation. A clear path-of-travel of thirty-six (36) inches wide shall be maintained in and around street features and arrangement.

B. Seating. Seating should be physically comfortable and inviting, durable and attractive. Plaza and open space seating should also be socially comfortable by offering a variety of choices such as in the sun or shade, near traffic and activity or not, and alone or in groups.

C. Drinking Fountains. Placing drinking fountains in new development is encouraged. Fountains should be placed within general areas of pedestrian traffic and located on accessible surfaces.

D. Trash Receptacles. Trash receptacles should blend visually with their surroundings and their design and location should make use as convenient as possible.

E. Vending Machines. Vending machines will not dispense items other than newspapers and periodicals. Vending machines shall be clustered together and away from intersection corners.

F. Vending Carts and Kiosks. Vending carts and kiosks are encouraged in locations that do not impede normal pedestrian traffic.

G. Outdoor Dining. Lease of public right-of-way for outdoor dining is encouraged in appropriate locations. Lease of sidewalk space for outdoor dining shall be managed through the department of parks and recreation and shall comply with all city codes. It is recommended that at least eight (8) feet of sidewalk be retained between the curb and the leased or licensed space to provide an uninterrupted public walkway.

H. Street Objects. Utility boxes, vending machines and so on should not be located in sidewalk zones. Their design and color should be compatible with character of their surroundings.

(4) Streetscape Landscaping. Landscaping, particularly streets trees, are an important addition to the streetscape because of the hot Texas climate. Appropriate application along sidewalks strengthens the visual quality of public streets. Careful selection of plant materials, using native and low-water use plants, is recommended.

(b) Skywalks and Underground Walkways. Skywalks and underground walkways between buildings but over (or under) public right-of-way shall be integral design elements of a total development, not merely passageways.

(1) Skywalks. Skywalks should avoid impeding vistas and views, particularly in the downtown, of historic landmarks, the river, and other important buildings. Construction shall be considered on an individual basis but shall not occur over the river. Skywalks shall facilitate interoffice communication and traffic rather than serve as a public walkway.

(2) Underground Walkway. Underground walkways or tunnels shall facilitate interoffice communication rather than serve as a public walkway. Underground walkways should include light wells, skylights, landscaping, and fresh air ventilation.

(c) Awnings and Canopies. The primary purpose of an awning shall be to provide shade and weather protection to pedestrians.

(1) Size and Shape. Awnings shall be proportionate in shape and size to the scale of the building facade to which it will be attached. On historic landmarks or on older buildings, awnings shall be historically appropriate in design and materials.

(2) Materials and Lettering. Preferred materials for fabric awnings are fire resistant canvas. Metal canopies may also be appropriate. Lettering on fabric awnings shall be permitted on the front flap only of the awning in a manner proportional to the awning size, but not to exceed one-half ( $\frac{1}{2}$ ) the area of the front flap. Symbols or logos may be allowed on the top of the awning not to exceed one-sixth ( $\frac{1}{6}$ ) of the square footage of the top of the awning.

## *Unified Development Code, Chapter 12, Public Art*

Historically, cities embrace the arts of their time. The character, personality and spirit of the city is often conveyed most vividly through its arts and culture. Downtown stakeholders benefit from a commitment to public art, for maintaining a strong arts and cultural presence is a significant factor in cultivating livable neighborhoods. As a result, Downtown is an increasingly popular destination to experience art and cultural activities, including viewing public art, attending art openings and festivals, or to enjoy a performance or traditional celebrations within a rich and enhanced urban setting. For these reasons, projects within Downtown should include public art and aspire to meet the following goals and guidelines:

### A. GOALS

Integrate public art in the overall vision of the project's architecture, landscape and open space design by incorporating the artist into the design team early in the process. The goals are as follows:

- Artistic excellence. Aim for the highest aesthetic standards by enabling artists to create original and sustainable artwork, with attention to design, materials, construction, and location, and in keeping with the best practices in maintenance and conservation.
- Visibility. Generate visual interest by creating focal points, meeting places, landmarks, modifiers or definers that will enhance Downtown's image locally, regionally, nationally and internationally.
- Authenticity. Enliven and enhance the unique quality of Downtown's sense of place, adding to its diverse visual and cultural environments. Provide meaningful opportunities for communities to participate in cultural planning, and for citizens and neighbors to identify and connect with each other through arts and culture in common areas.
- Cultural literacy. Foster common currency for social and economic exchange between residents, and attract visitors by ensuring that they have access to visual 'clues' that will help them navigate and embrace a potentially unfamiliar environment. This can be further achieved through promotional materials and tours that enhance and expand upon the impact of public art installations.
- Appropriateness. Artworks must meet or exceed professional standards for visual art, ultimately adding to the relevancy and appreciation of the city's collection of public art and will illustrate themes and levels of sophistication that are appropriate for their location.
- Responsiveness. Without formally injecting art into the early stages of the planning process for each new development, it will either be left out, or appear out of sync with the overall growth of the built environment.

### B. GENERAL GUIDELINES

1. All artwork erected in or placed upon City property must be approved by the Public Art Board. In cases where artwork is erected or placed upon private properties located within a designated historic districts or historic overlay districts, approvals must be approved by the Public Art Board and the Historic and Design Review Commission.

### **FINDINGS:**

- a. The applicant is requesting a Certificate of Appropriateness for the approval of a master plan for the River Walk Public Art Garden. The Public Art Garden is located at both the street and river levels on the City owned block bounded by E Commerce, E Market, S Alamo and Bowie Streets. The proposed master plan includes three major focuses: 1) site improvements; 2) an innovative program of permanent and temporary art installations; and 3) a site signage package.
- b. **SITE IMPROVEMENTS** – The applicant has proposed site improvements that include character defining artwork, focal paintings and fathering spaces. The applicant has identified Peak's Part, located on the north river-level terrace as a garden; the Heart, located on the east river level adjacent to the Marriott hotel as a garden and

the street level lawn on Market as a civic space with landscaping and pedestrian pathways.

- c. SAMUEL GOMPERS STATUE RELOCATION – Within this application, the applicant has proposed to relocate the Samuel Gompers statue to storage. Plans for the statue’s relocation have not been determined at this time.
- d. PERMANENT AND TEMPORARY ART INSTALLATIONS – The applicant has noted that both permanent and temporary art installations will be phased into the proposed Public Art Garden. The applicant has noted that four locations have been identified as locations for large scale permanent installations in addition to five to seven locations that will feature art installations with pedestals, foundations and/or wall anchors. Additional lighting, signage and open sight lines will be added to enhance the pedestrian experience. Staff finds that installations should not damage existing and historic River Walk architectural or site elements.
- e. MATERIALS – The applicant has proposed materials that include precast concrete site furnishings, precast concrete pavers, lighting fixtures and composite decking materials. Generally, staff finds the proposed materials to be appropriate.
- f. LANDSCAPE MATERIALS – The applicant has proposed a number of landscaping materials that are native to the San Antonio Region. Staff finds the proposed landscaping plants to be appropriate.
- g. SIGNAGE – The applicant has proposed a number of signage elements which includes artwork labels, introductory panels, location signage and updates to directional and informational signage at both the river and street levels.
- h. SIGNAGE (TYPEFACES) – The applicant has proposed the typeface “Union” for signage and has provided examples of the four weights of this typeface. Staff finds the proposed typeface to be appropriate.
- i. SIGNAGE (COLORS) – The applicant has proposed four signage colors to be complementary of the natural colors found at the River Walk level. These colors include “Leaf”, “Paver” and “Stone”. Staff finds the proposed signage panel colors to be appropriate.
- j. SIGNAGE (STREET LEVEL) – At the street level, the applicant has proposed signage to read “Public Art Garden” to feature two sets mirrored stainless-steel channel letters. The proposed signage will feature two sizes: 2’ – 3” in height and approximately 24’ – 0” in length for a total size of approximately 54 square feet and 2’ – 5” in height and 26’ – 0” in length for approximately 65 square feet in size. The applicant has noted that the exact text and location of the proposed signage is to be determined.
- k. SIGNAGE (INTRODUCTORY PANELS) – The applicant has noted the installation of an introductory panel at the River Walk level to feature forty-four (44) inches in height and twenty-seven (27) inches in width for a size of approximately 8.25 square feet in size. The sign will be porcelain enamel and will be mounted to an existing, stone wall. Staff finds the proposed size and placement of the sign to be appropriate; however, the sign should be installed in a manner that does not result in permanent damage to the wall.
- l. SIGNAGE (ARTWORK LABELS) – The applicant has proposed a number of artwork labels that are to accompany temporary pieces of art. The proposed labels will feature porcelain enamel panels affixed to stakes. The proposed overall height is two feet with panels featuring widths of two feet and heights of two feet. Staff finds the proposed panels to be appropriate.
- m. SIGNAGE (FLAGS) – The applicant has proposed a flag pole that feature thirty (30) feet in height. The applicant has noted that each flag pole will feature a system of flags that will announce each artwork on view. Staff finds the installation of the proposed flag system to be appropriate provided that the installed flags do not feature commercial branding or off premise advertising.
- n. TEMPORARY SIGNAGE – The applicant has proposed temporary signage to include screening for construction activities as well as banners that advertise upcoming exhibits. Temporary signage that does not include commercial branding or off premise advertising is appropriate and may be eligible for administrative approval.
- o. ARCHAEOLOGY – The project shall comply with all federal, state, and local laws, rules, and regulations regarding archaeology.

## **RECOMMENDATION:**

Staff recommends approval of the proposed master plan with the following stipulations:

- i. That individual signs be submitted to OHP staff for review and approval prior to installation.
- ii. That signage, art installations and site elements be installed in a manner that does not damage existing River Walk elements.
- iii. ARCHAEOLOGY – The project shall comply with all federal, state, and local laws, rules, and regulations regarding archaeology.

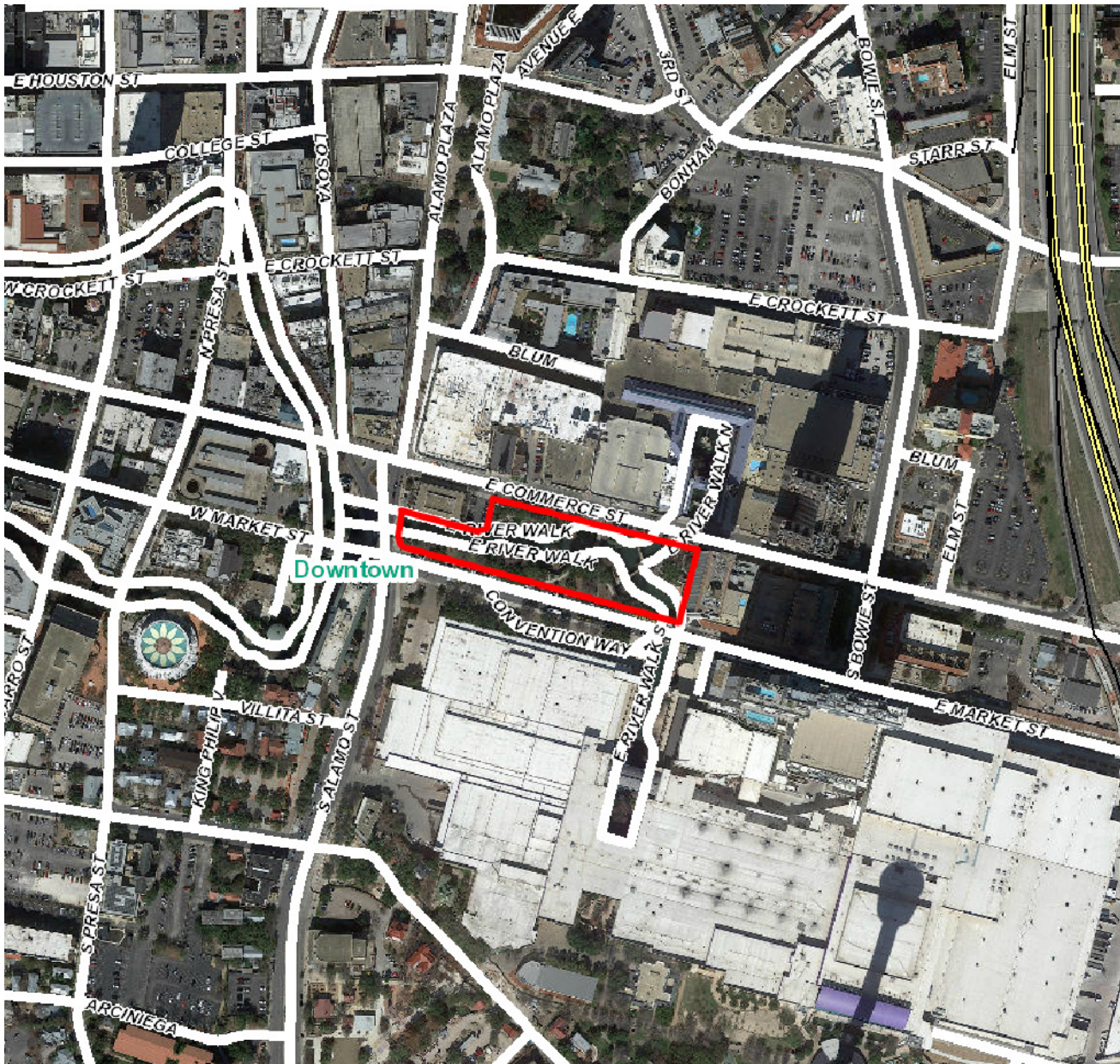

	<h2>Flex Viewer</h2>	<p>Printed: Mar 09, 2019</p>
	<p>Powered by ArcGIS Server</p>	

The City of San Antonio does not guarantee the accuracy, adequacy, completeness or usefulness of any information. The City does not warrant the completeness, timeliness, or positional, thematic, and attribute accuracy of the GIS data. The GIS data, cartographic products, and associated applications are not legal representations of the depicted data. Information shown on these maps is derived from public records that are constantly undergoing revision. Under no circumstances should GIS-derived products be used for final design purposes. The City provides this information on an "as is" basis without warranty of any kind, express or implied, including but not limited to warranties of merchantability or fitness for a particular purpose, and assumes no responsibility for anyone's use of the information.



E Market St

E Commer

Losoya St

River Walk

HDRC Application Form  
River Walk Public Art Garden Master Plan

Public Hearing, March 20, 2019

Site Photos	3
Project Narrative	10
Site Plan	15
Elevation Drawings & Plans	16
Materials	24
Signage	31

















In 2018, the City of San Antonio established a new public art initiative, the River Walk Public Art Garden. The Public Art Garden is located on the San Antonio River Walk at street and river level on the City-owned block bound by East Commerce Street and East Market Street, and S. Alamo Street and Bowie.

Conceived as an outdoor museum, the River Walk Public Art Garden utilizes land not considered since 1968—when it was built as a link to the World’s Fair—to celebrate public art throughout San Antonio. This initiative will reinvent three acres along the River Walk, as a welcoming space for residents and visitors to connect with art in a beautiful outdoor setting. The intent is to create inviting gathering spaces, commission iconic and place-defining artworks by diverse artists, and become a garden that grows and connects artworks throughout San Antonio’s far-reaching neighborhoods.

Implementation of this multi-year initiative will be guided by the River Walk Public Art Garden Master Plan. The Department of Arts & Culture, through its Public Art Division is leading the project in coordination with CCDO and Parks & Recreation. The master plan includes three major focuses: 1) site improvements; 2) an innovative program of permanent and temporary art installations; and 3) a site signage package.



## 1) Site improvements

Site improvements concentrate on the underutilized street and river-level gardens. The river level improvements are intended to create distinct gardens with character defining artwork, focal plantings, and gathering spaces. Peak's Park, located on north river-level terrace is identified as one garden; the Heart, located on the east river-level in front of the Marriot is another; and the street level lawn on Market Street will become an inviting civic space with plantings and pathways that will draw visitors to new overlooks and connect to the enhancements on the south side of Market Street. The Samuel Gompers statue will be relocated to storage with the support of the ALFCIO and the San Antonio Arts Commission (it was assessed to be a public safety concern). In addition to permanent artworks, the new gathering spaces will support cultural and community programming.

## 2) An innovative program of permanent and temporary art installations

Public art locations have been identified for artwork installations that will be phased into the Public Art Garden over the next three years. Four locations have been identified as opportunities for large-scale permanent artworks to highlight the gardens described above, and the site entrance through the Alamo St Bridge tunnel. In addition to the four permanent artworks, five to seven locations will be established as art locations with pedestals, foundations or wall anchors. These art locations will be used to exhibit commissioned and/or loaned artworks, including neighborhood public art that will debut downtown before being relocated permanently to parks, creeks, greenway trails, city owned facilities and other public spaces. Upgrades will be made to the site to ensure pedestrian access, enhance lighting, add artwork signage, and open lines of sight to view new artworks.

### 3) A site signage package

Signage for the Public Art Garden will consist of artwork labels, introductory panels, location signage, and any appropriate updates to the existing directional and information signage at river and street-level. A color palette has been identified in order to match signs to their surroundings and receding into the background environment. Mirrored stainless steel signs will be placed at street-level that will serve as monument signs (exact text and location still to be determined), as well as placement of a flag pole that announces new artworks through artist-designed nylon flags. A package of temporary signage, such as bridge banners, event signs and construction fencing, will highlight upcoming installations, and establish a distinct visual continuity within the grounds of the Public Art Garden.

The River Walk Public Art Garden Master Plan envisions a world-class destination dedicated to public art by distinguished local and international artists set within the lush garden environment of the San Antonio River Walk extension. This transformative initiative builds on the legacy of 1968 to create a cultural hub in the heart of downtown that will deepen San Antonio's access and appreciation of art and inspire generations to come.

The Antonio River Walk Public Art Garden Master Plan is funded through the 2017-2022 Bond Program and will connect with public art commissions being developed in all ten city council districts.

Site Plan

- MARKET STREET PLANTING (mixed garden perennials, low shrubs, groundcover and pocket lawns at art locations)
- RIPARIAN PLANTING (planting centered around bald cypress trees and native central texas riparian conditions)
- TROPICAL PLANTING (lush, full plantings centered around existing palms, fronds, and ferns)
- CULTIVATION PLANTING (high color annual and perennial beds with direct relation to sited artworks)
- PREFERRED FLAG LOCATION
- ART WALL
- ART LOCATION
- SITE SIGNAGE/IDENTIFIER

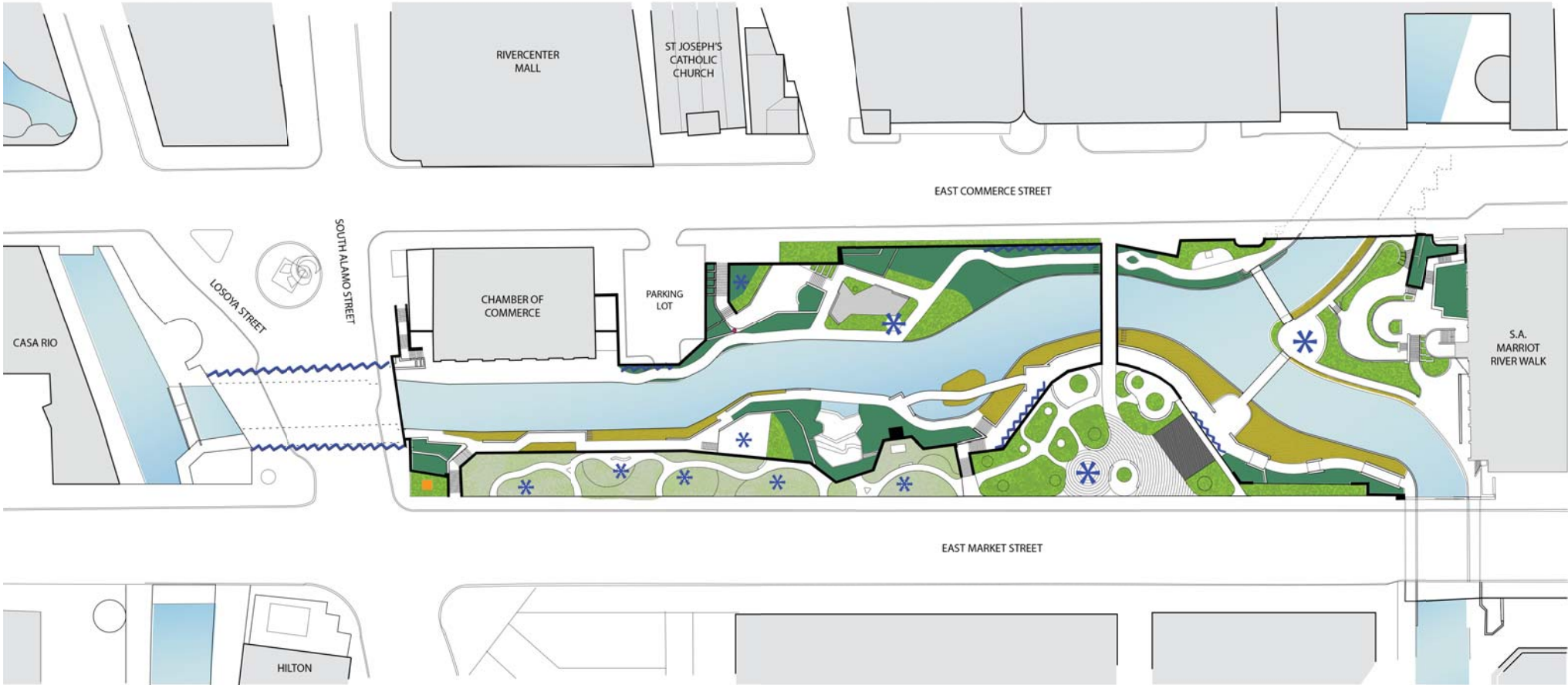

Elevation Drawings & Plans

- SHEET LIST  
L100 - CONCEPTUAL SITE PLAN  
L102 - ALAMO STREET BRIDGE  
L202 - PEAKS PARK  
L302 - THE FOUNTAIN  
L402 - MARKET STREET PLAZA  
L502 - SAN ANTONIO T  
L602 - THE HEART

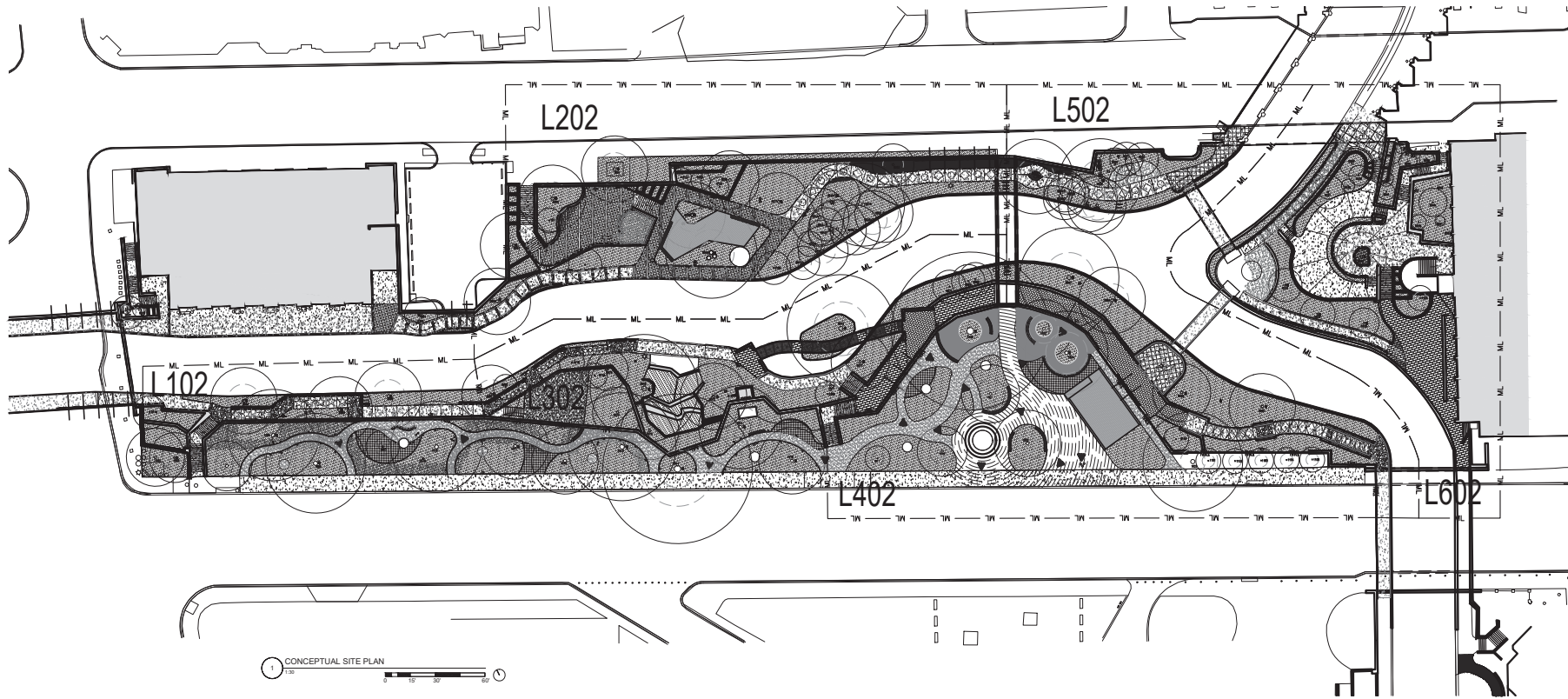
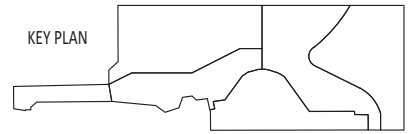

# Elevation Drawings & Plans

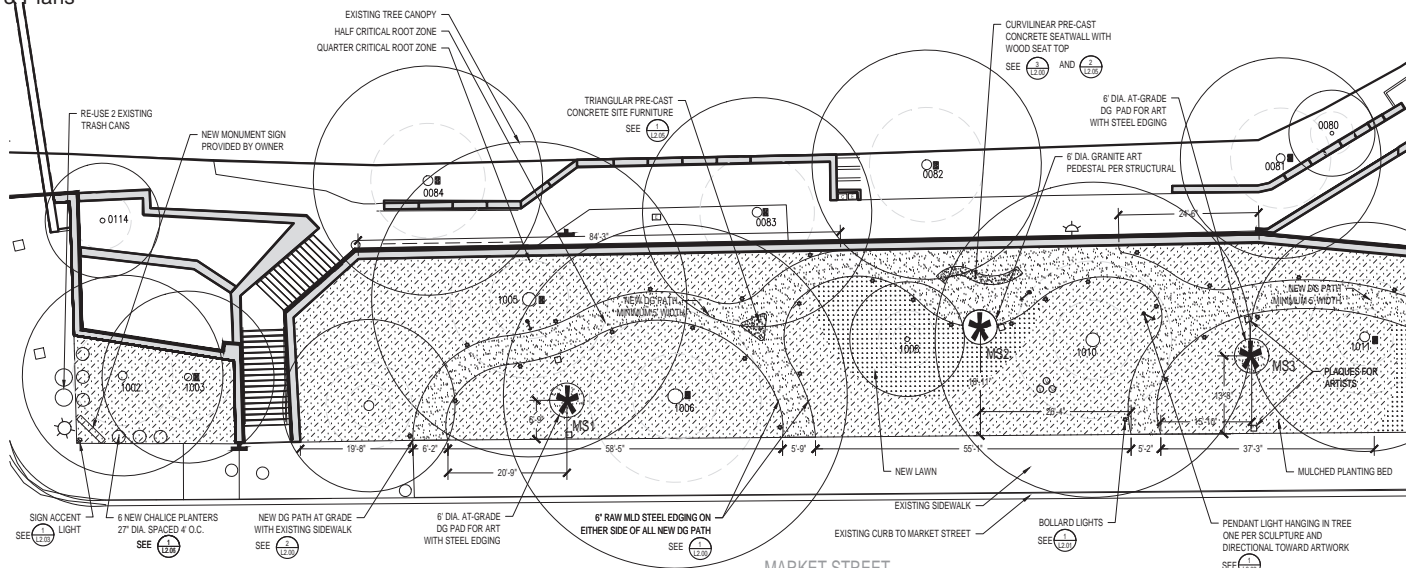

1 WEST LAYOUT & MATERIALS PLAN

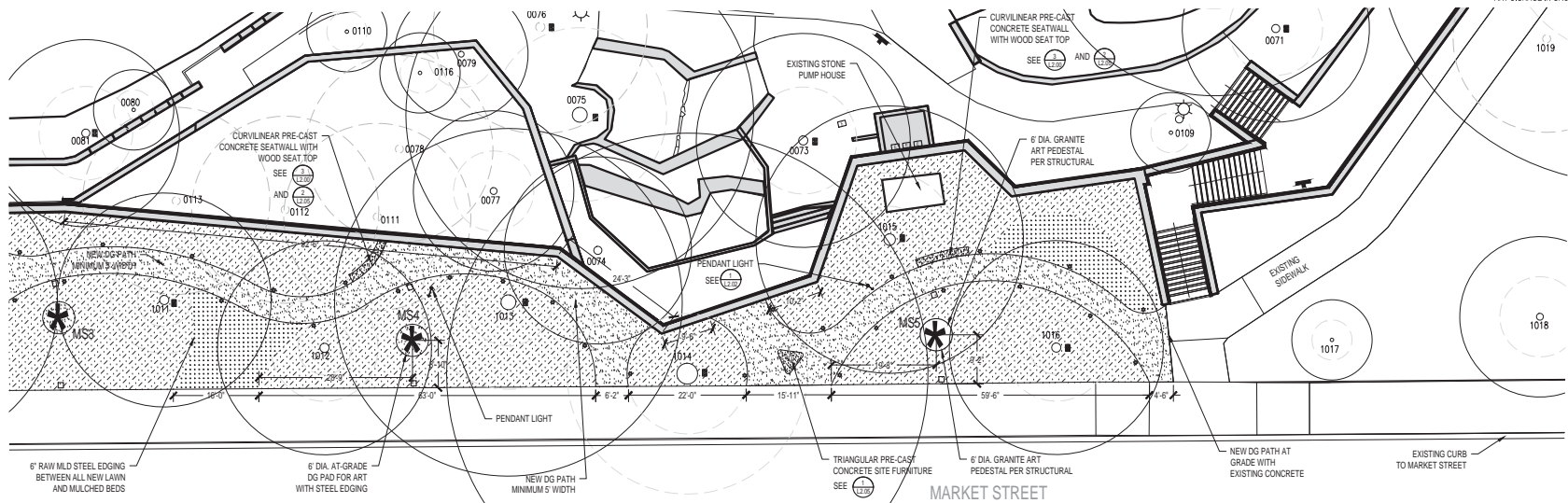

2 EAST LAYOUT & MATERIALS PLAN

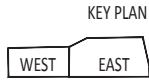













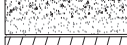









## LEGEND

- EXISTING TREE TRUNK WITH CANOPY CRZ AND HALF CRZ AND QUARTER CRZ
- NEW DECOMPOSED GRANITE
- NEW CONCRETE
- NEW LAWN
- NEW MULCH
- PROPOSED ACCENT LIGHT
- PROPOSED BOLLARD LIGHT
- PROPOSED DIRECTIONAL PENDANT LIGHT
- EXISTING PEDESTRIAN LIGHT POLE
- PROPOSED 3D ART
- EXISTING SIGN
- EXISTING SITE WALLS
- EXISTING TREE JUNCTION BOX
- EXISTING ELECTRICAL BOX
- EXISTING COMMUNICATION BOX
- EXISTING WATER VALVE
- EXISTING ELECTRICAL OUTLET
- STEEL EDGER
- ART SIGNAGE IN GROUND

Elevation Drawings & Plans

LEGEND

	NEW DECK		PROPOSED ACCENT LIGHT
	NEW LIMESTONE FINES GRAVEL		PROPOSED BOLLARD LIGHT
	NEW DECOMPOSED GRANITE		PROPOSED DIRECTIONAL PENDANT LIGHT
	NEW PRE-CAST CONCRETE PAVER PLAZA		EXISTING PEDESTRIAN LIGHT POLE
	NEW PRE-CAST CONCRETE SEATING		PROPOSED 3D ART
	NEW LAWN		EXISTING SIGN
	NEW MULCH		EXISTING SITE WALLS
	EXISTING TREE TRUNK WITH CANOPY CRZ AND HALF CRZ AND QUARTER CRZ		EXISTING TREE JUNCTION BOX
			EXISTING ELECTRICAL BOX
			EXISTING COMMUNICATION BOX
			EXISTING WATER VALVE
			EXISTING ELECTRICAL OUTLET
			STEEL EDGER
			ART SIGNAGE IN GROUND

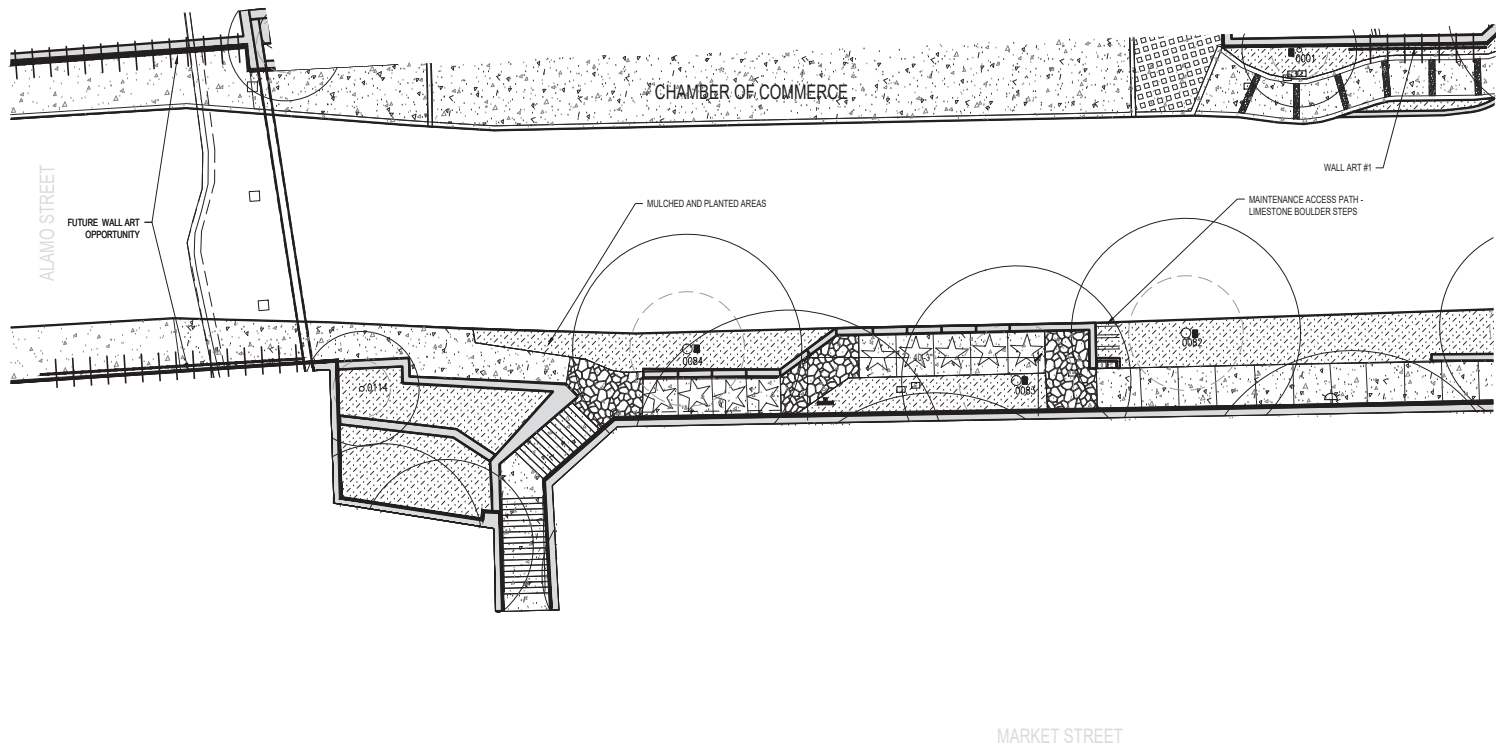
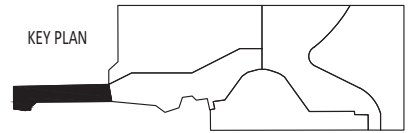





ALAMO ST BRIDGE LAYOUT & MATERIALS PLAN





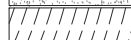
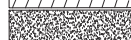

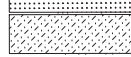

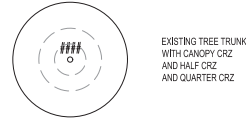





MARKET STREET



LEGEND







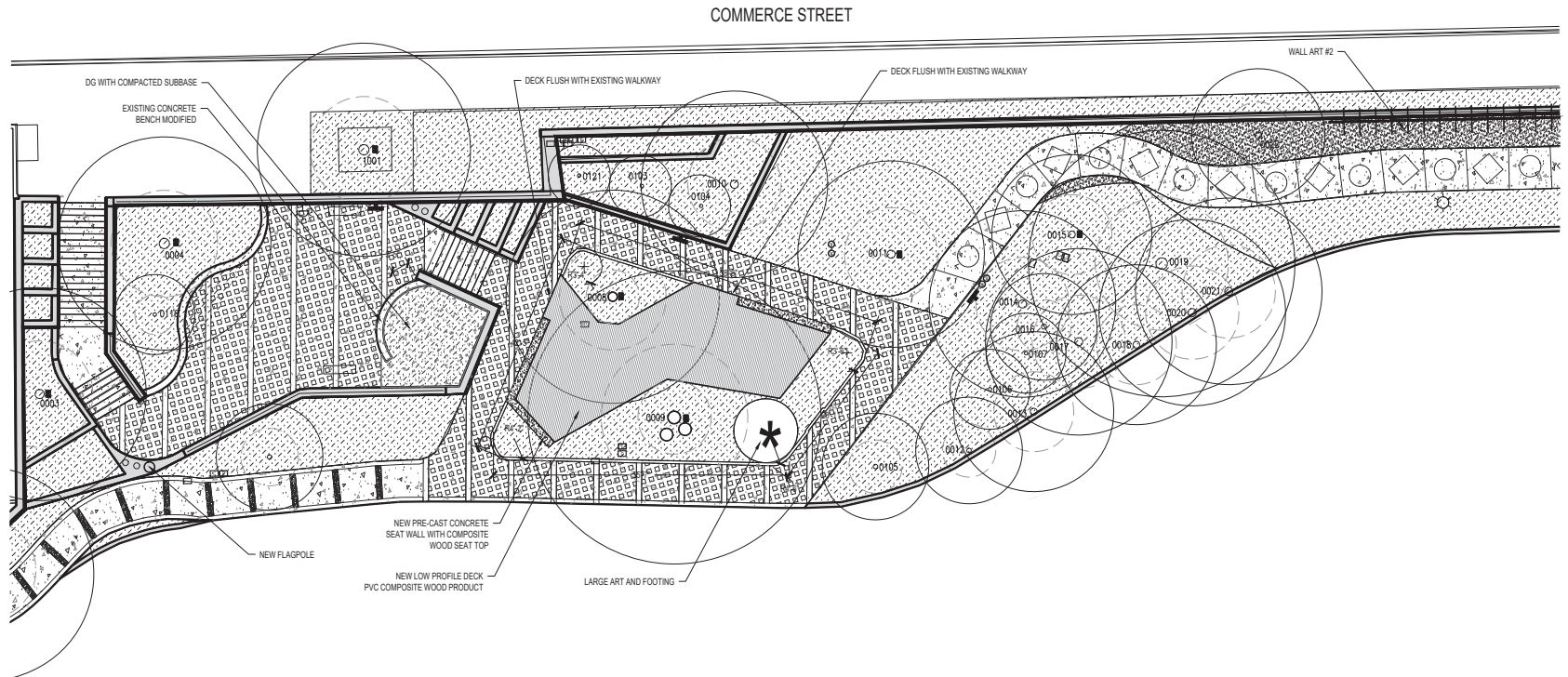



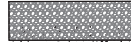
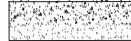

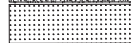





-  NEW DECK
-  NEW LIMESTONE FINES GRAVEL
-  NEW DECOMPOSED GRANITE
-  NEW PRE-CAST CONCRETE PAVER PLAZA
-  NEW PRE-CAST CONCRETE SEATING
-  NEW LAWN
-  NEW MULCH



-  PROPOSED ACCENT LIGHT
-  PROPOSED BOLLARD LIGHT
-  PROPOSED DIRECTIONAL PENDANT LIGHT
-  EXISTING PEDESTRIAN LIGHT POLE
-  PROPOSED 3D ART
-  EXISTING SIGN
-  EXISTING SITE WALLS
-  EXISTING TREE JUNCTION BOX
-  EXISTING ELECTRICAL BOX
-  EXISTING COMMUNICATION BOX
-  EXISTING WATER VALVE
-  EXISTING ELECTRICAL OUTLET
-  STEEL EDGER
-  ART SIGNAGE IN GROUND



LEGEND

-  NEW DECK
-  NEW LIMESTONE FINES GRAVEL
-  NEW DECOMPOSED GRANITE
-  NEW PRE-CAST CONCRETE PAVER PLAZA
-  NEW PRE-CAST CONCRETE SEATING
-  NEW LAWN
-  NEW MULCH
-  PROPOSED ACCENT LIGHT
-  PROPOSED BOLLARD LIGHT
-  PROPOSED DIRECTIONAL PENDANT LIGHT
-  EXISTING PEDESTRIAN LIGHT POLE
-  PROPOSED 3D ART
-  EXISTING SIGN
-  EXISTING SITE WALLS
-  EXISTING TREE JUNCTION BOX
-  EXISTING ELECTRICAL BOX
-  EXISTING COMMUNICATION BOX
-  EXISTING WATER VALVE
-  EXISTING ELECTRICAL OUTLET
-  STEEL EDGER
-  ART SIGNAGE IN GROUND



EXISTING TREE TRUNK WITH CANOPY CRZ AND HALF CRZ AND QUARTER CRZ

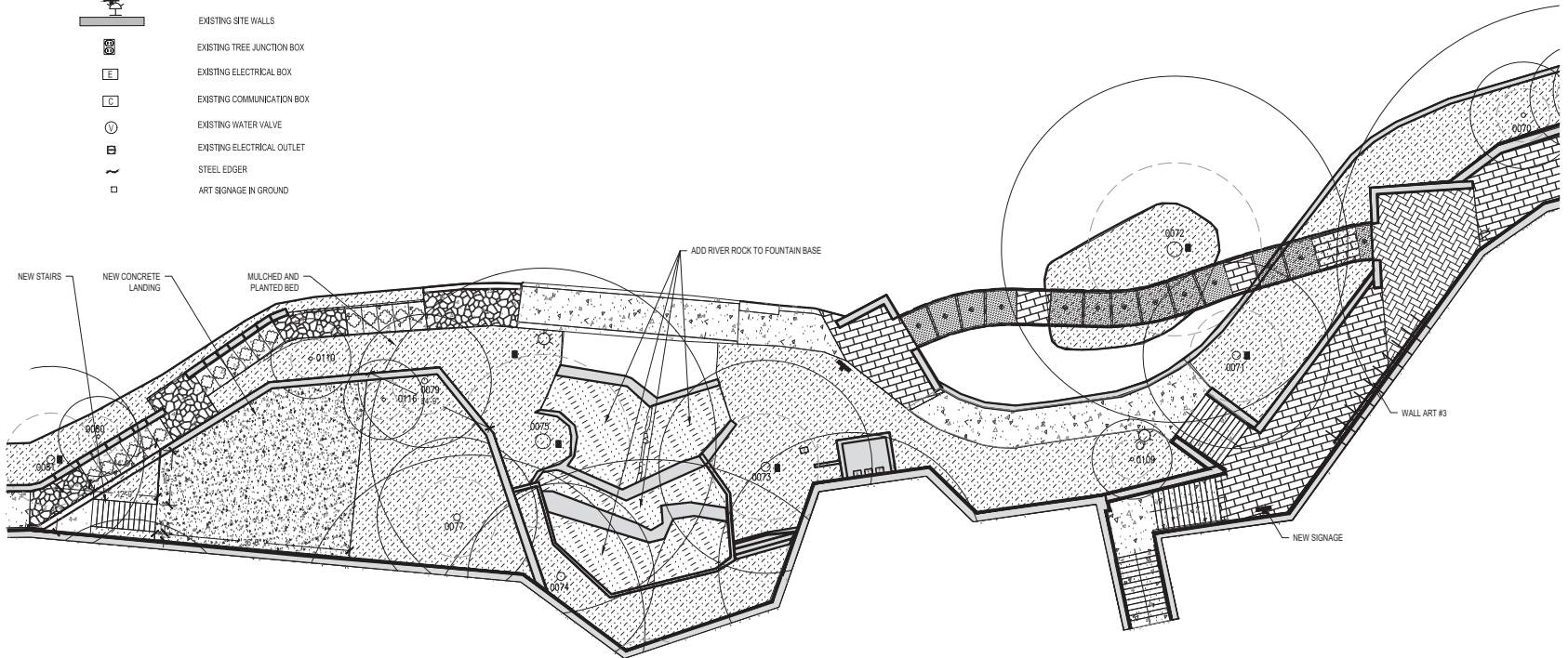
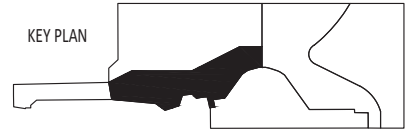















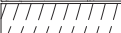





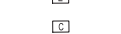

FOUNTAIN LAYOUT & MATERIALS PLAN

MARKET STREET

Elevation Drawings & Plans



LEGEND

-  EXISTING TREE TRUNK WITH CANOPY CRZ AND HALF CRZ AND QUARTER CRZ
-  NEW DECK
-  NEW LIMESTONE FINES GRAVEL
-  NEW DECOMPOSED GRANITE
-  NEW PRE-CAST CONCRETE PAVER PLAZA
-  NEW PRE-CAST CONCRETE SEATING
-  NEW LAWN
-  NEW MULCH
-  PROPOSED ACCENT LIGHT
-  PROPOSED BOLLARD LIGHT
-  PROPOSED DIRECTIONAL PENDANT LIGHT
-  EXISTING PEDESTRIAN LIGHT POLE
-  PROPOSED 3D ART
-  EXISTING SIGN
-  EXISTING SITE WALLS
-  EXISTING TREE JUNCTION BOX
-  EXISTING ELECTRICAL BOX
-  EXISTING COMMUNICATION BOX
-  EXISTING WATER VALVE
-  EXISTING ELECTRICAL OUTLET
-  STEEL EDGER
-  ART SIGNAGE IN GROUND

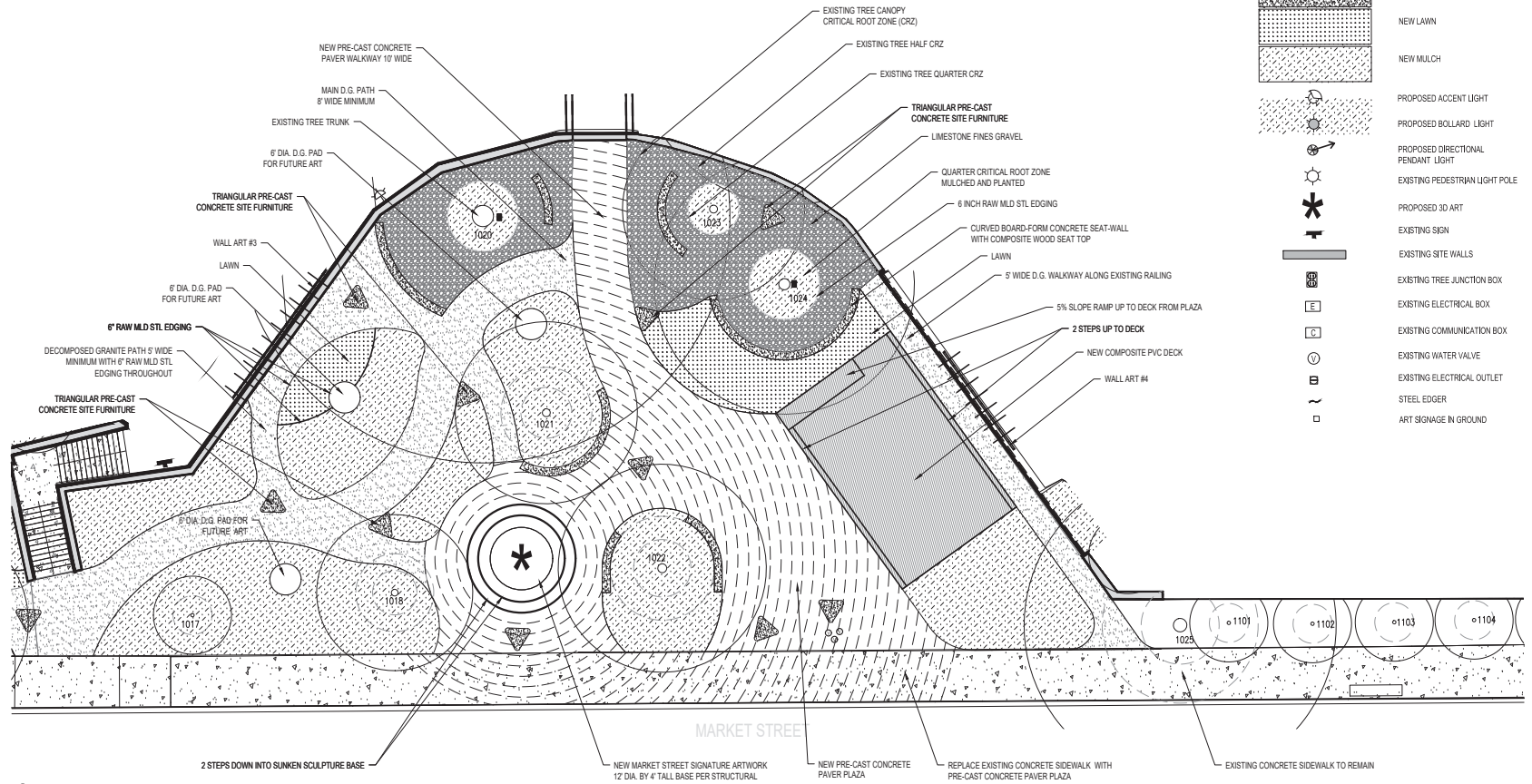

MARKET STREET PLAZA LAYOUT & MATERIALS PLAN  
1:100

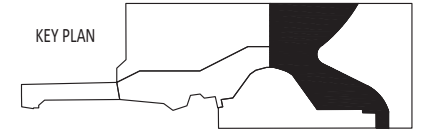
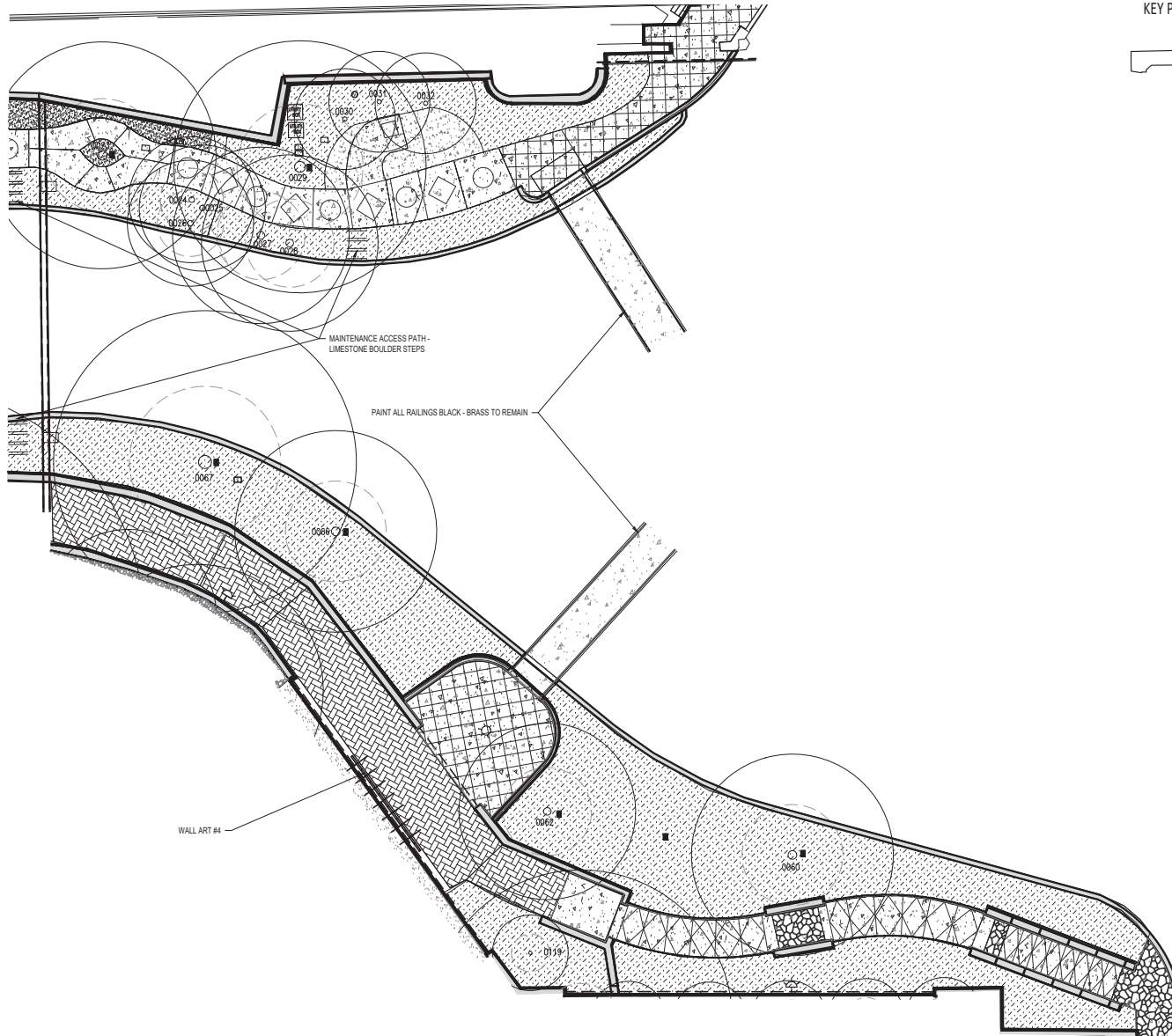

LEGEND

- EXISTING TREE TRUNK WITH CANOPY CRZ AND HALF CRZ AND QUARTER CRZ
- NEW DECK
- NEW LIMESTONE FINES GRAVEL
- NEW DECOMPOSED GRANITE
- NEW PRE-CAST CONCRETE PAVER PLAZA
- NEW PRE-CAST CONCRETE SEATING
- NEW LAWN
- NEW MULCH
- PROPOSED ACCENT LIGHT
- PROPOSED BOLLARD LIGHT
- PROPOSED DIRECTIONAL PENDANT LIGHT
- EXISTING PEDESTRIAN LIGHT POLE
- PROPOSED 3D ART
- EXISTING SIGN
- EXISTING SITE WALLS
- EXISTING TREE JUNCTION BOX
- EXISTING ELECTRICAL BOX
- EXISTING COMMUNICATION BOX
- EXISTING WATER VALVE
- EXISTING ELECTRICAL OUTLET
- STEEL EDGER
- ART SIGNAGE IN GROUND

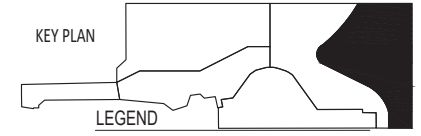
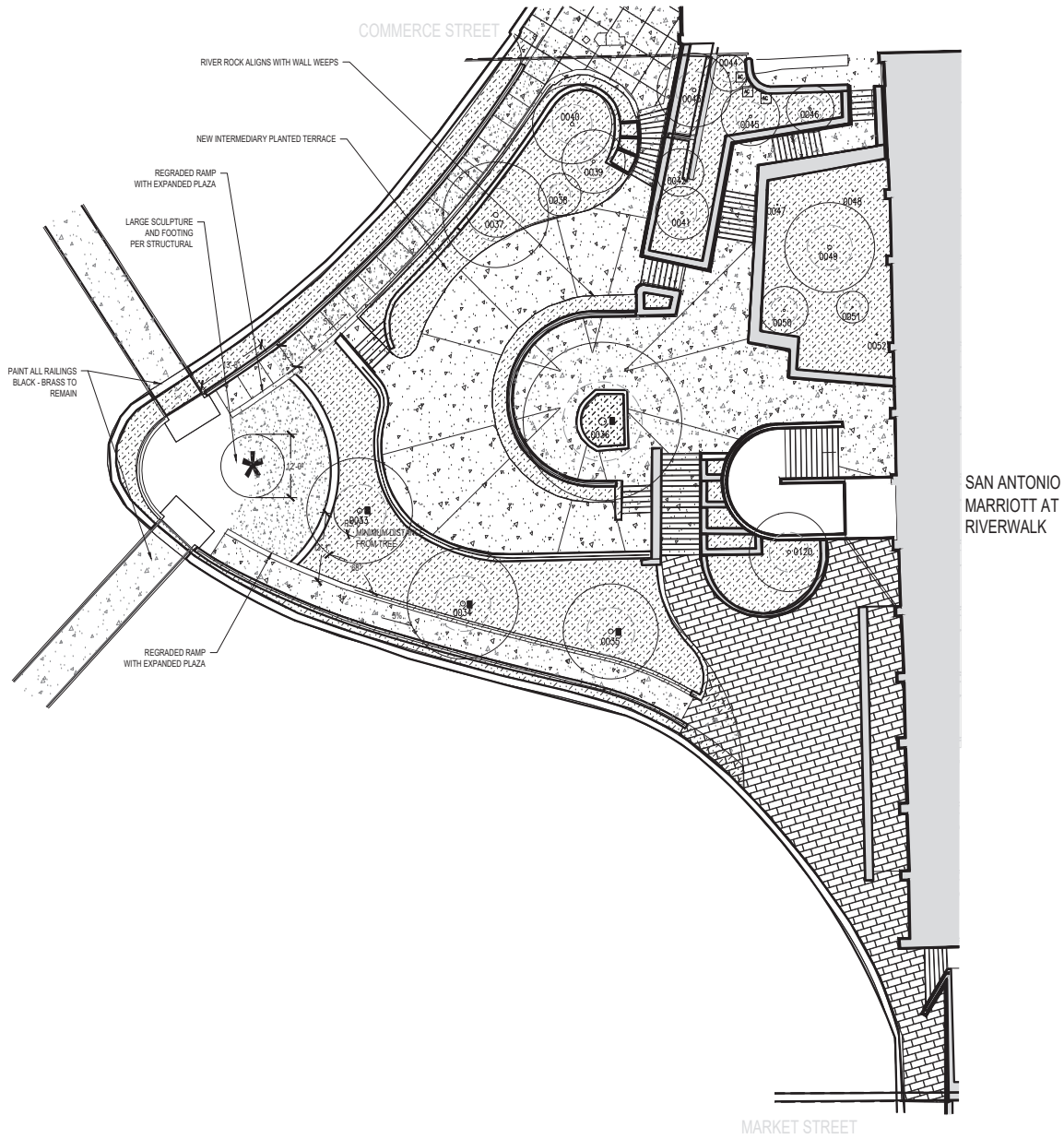

**LEGEND**

	EXISTING TREE TRUNK WITH CANOPY CRZ AND HALF CRZ AND QUARTER CRZ
	NEW DECK
	NEW LIMESTONE FINES GRAVEL
	NEW DECOMPOSED GRANITE
	NEW PRE-CAST CONCRETE PAVER PLAZA
	NEW PRE-CAST CONCRETE SEATING
	NEW LAWN
	NEW MULCH
	PROPOSED ACCENT LIGHT
	PROPOSED BOLLARD LIGHT
	PROPOSED DIRECTIONAL PENDANT LIGHT
	EXISTING PEDESTRIAN LIGHT POLE
	PROPOSED 3D ART
	EXISTING SIGN
	EXISTING SITE WALLS
	EXISTING TREE JUNCTION BOX
	EXISTING ELECTRICAL BOX
	EXISTING COMMUNICATION BOX
	EXISTING WATER VALVE
	EXISTING ELECTRICAL OUTLET
	STEEL EDGER
	ART SIGNAGE IN GROUND

THE HEART LAYOUT & MATERIALS PLAN  
1" = 10'

Materials: Art Garden Precedents



Culiacan Botanic Garden, Mexico



Norton Simon Museum, California



Materials: Riparian Planting Palette



Dwarf Sabal  
*Sabal minor*



Silver Saw Palmetto  
*Seroena rapens*



Umbrella Sedge  
*Cyperus alternifolius*



Butterfly Iris  
*Dietes grandiflora*



Cape Rush  
*Chondropetalum tectorum*



Inland Sea Oats  
*Chasmanthium latifolium*



Berkeley Sedge  
*Carex divulsa*



River Fern  
*Thelypteris kunthii*



Maidenhair Fern  
*Adiantum pedatum*

Materials: Tropical Planting Palette



Turks Cap  
*Malvastrum arboreus*



Firecracker Fern  
*Russelia equisetiformis*



Coralbean  
*Erythrina herbacea*



Beautyberry  
*Callicarpa americana*



Bamboo Muhly  
*Muhlenbergia dumosa*



Leopard Plant  
*Farfugium japonicum*



Forsythia Sage  
*Salvia madrensis*



Dwarf Sabal  
*Sabal minor*



Virgin Palm  
*Dioon edule*



Variegated Ginger  
*Alpinia zerumbet variegata*



Firespike  
*Odontonema strictum*



Philodendron  
*Philodendron selloum*



Berekeley Sedge  
*Carex divulsa*



Shrimp Plant  
*Justicia brandegeenana*



Hoja Santa  
*Piper auritum*



Hoja Santa  
*Piper auritum*



Dianella  
*Dianella caerulea*



Inland Sea Oats  
*Chasmanthium latifolium*



Materials: Cultivation Planting Palette



Buttonbush  
*Cephalanthus occidentalis*



Esperanza  
*Tecoma stans*



Firecracker Fern  
*Russelia equisetiformis*



Bamboo Muhly  
*Muhlenbergia dumosa*



Pink Parade Yucca  
*Hesperaloe x 'perfu'*



Pride Of Barbados  
*Caesalpinia pulcherrima*



Dwarf Sabal  
*Sabal minor*



River Fern  
*Thelypteris kunthii*



Bougainvillea  
*Bougainvillea "Scarlet O'Hara"*



Philodendron  
*Philodendron selloum*



Plumbago  
*Plumbago auriculata*



Inland Sea Oats  
*Chasmanthium latifolium*



Berkely Sedge  
*Carex tumulicola*



Yellow Columbine  
*Aquilegia chrysantha var. 'hinckleyana'*



Crinum Lily  
*Crinum spp.*



Giant Spider Lily  
*Crinum spp.*



Spider Lily  
*Hymenocallis americana*

Materials: Market Street Planting Palette



Wild Narcissus  
*Narcissus pseudonarcissus*



Spider Lily  
*Hymenocallis americana*



Oxblood Lily  
*Rhodophiala bifida*



Rain Lily  
*Cooperia drummondii*



Firecracker Fern  
*Russelia equisetiformis*



Mexican Honeysuckle  
*Justicia spicigera*



Shrimp Plant  
*Justicia brandegeenana*



Fountaingrass  
*Pennisetum setaceum*



Bamboo Muhly  
*Muhlenbergia dumosa*



River Fern  
*Thelypteris kunthii*



Berkely Sedge  
*Carex divulsa*



Inland Sea Oats  
*Chasmanthium latifolium*



Clover Fern  
*Marsilea macropoda*

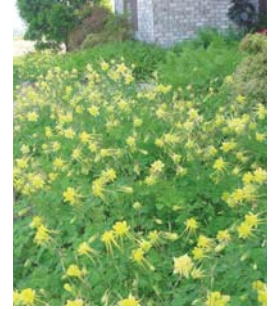

Yellow Columbine  
*Aquilegia chrysantha* var. 'hinckleyana'



Mexican Plum  
*Prunus mexicana*



Possumhaw  
*Ilex decidua*



Mexican Blue Palm  
*Brahea armata*



Silver Saw Palmetto  
*Serenoa rapens*



Buttonbrush  
*Cephalanthus occidentalis*



Ghost Plant  
*Graptopetalum paraguayense*



Bulbine  
*Bulbine frutescens*

Materials: Trees & Palms



Mexican Plum  
*Prunus mexicana*



Possumhaw  
*Ilex decidua*

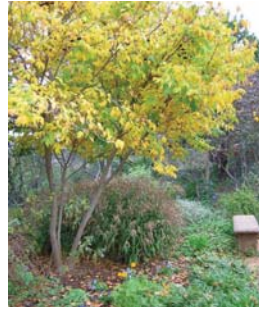

Mexican Buckeye  
*Ungnadia speciosa*



Mexican Blue Palm  
*Brahea armata*



Silver Saw Palmetto  
*Serenoa rapens*



Banana  
*Musa*

Materials



Precast Concrete Site Furnishings with PVC Composite Decking Material



Precast Concrete Pavers

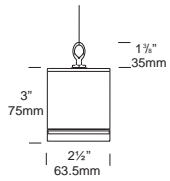

LED Tree Pendant



Modular, shielded 360 degree LED bollard light



LED Accent Light for Signage & Art



Integral Color Concrete Planters for Seasonal Interest



PVC Composite Decking & Low-Profile Adjustable Pedestal Footing

The typeface Union will be used for all signage. It comes in four weights.

abcdefghijklmnopqr uvwxyz  
ABCDEFGHIJKLM  
NOPQRSTUVWXYZ  
1234567890  
áâàäåãæçðéêèëïíîïìĩñ  
óôòöõøœßšþúûùüýÿž  
ÁÂÀÄÅÃÆÇÉÊÈËÏÎÏÌĨÑ  
ÓÔÒÖÕØŒŠÞÚÛÛÜÝŸŽ  
¡¿?.,:;...-—( ) [ ] { } / \ & \* @  
“”‘’·„,«»<>§•¶†‡©®™

**Regular**  
When we landed in San Antonio, we encountered symbols—the Alamo, stars, and a path woven from two threads.

**Regular Italic**  
*Acequia are like capillaries that carry water to parts of the city away from the river. They enable the missions to thrive.*

**Union Bold**  
**HemisFair '68 made San Antonio a true crossroads for international activity, especially in the arts.**

**Union Bold Italic**  
*There were many well-depicted representations of history. New and old coexisting everywhere.*

Signage: Concepts

- 1) Design in support of the vision of the site—a public art garden with both permanent and temporary/ moveable artwork
- 2) Engage with existing conditions as a means to present something new
- 3) Utilize a camouflage approach to signage by color matching to and experimenting with mirrored surfaces. By receding into or reflecting the environment, the signage system can claim a lighter, more nuanced voice in a visually rich and busy environment.
- 4) Signage can act as cues for River Barge operators, establish visual continuity throughout the whole site, and help audiences envision what is to come.

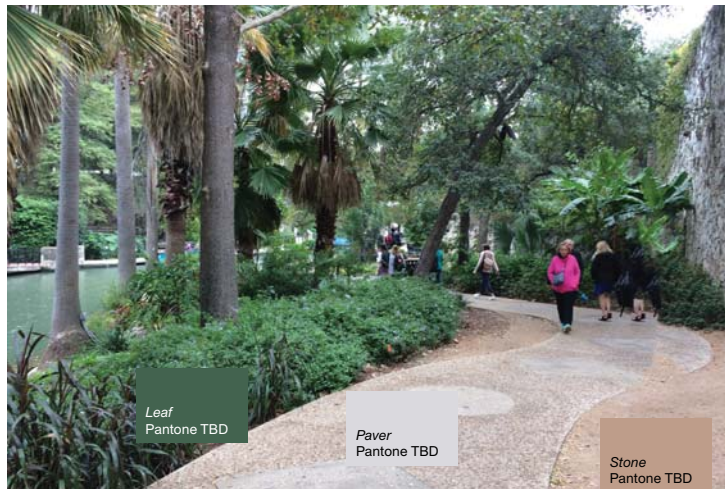

In a museum setting, labels are color matched to the wall to allow the artwork to be more prominent.

Signage: Permanent

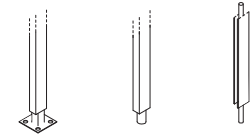

*Site sign, Street level, Commerce Street*  
Mirrored stainless steel

Mounting technique will dictate final design specifications

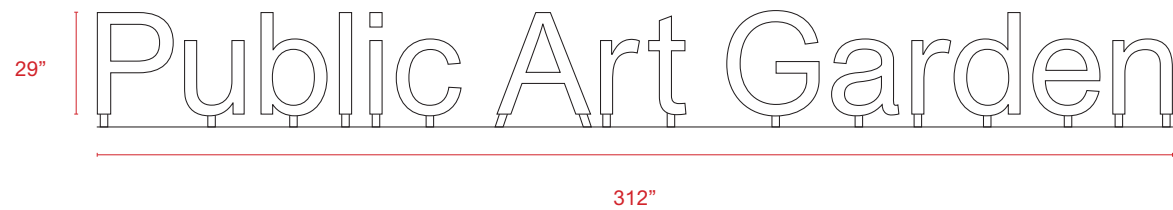

*Site sign, Street level, Market Street*  
Mirrored stainless steel

Signage: Permanent



Introductory Panel, Peak's Park  
Porcelain Enamel

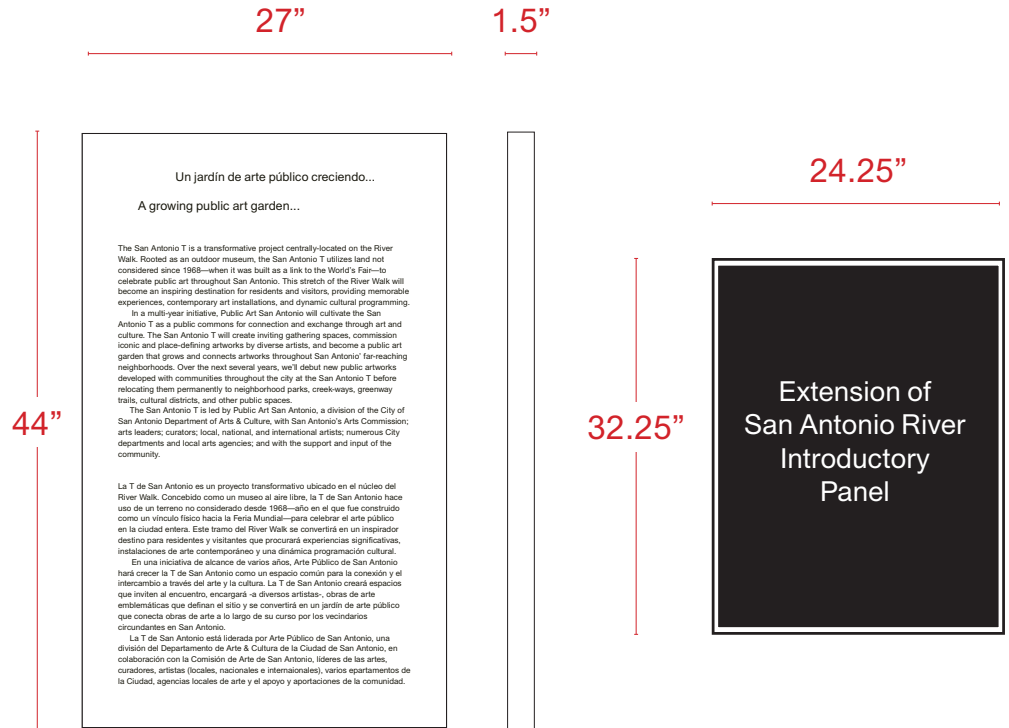

Text rendered in Spanish and English



Signage: Permanent



Artwork Labels, various locations  
Porcelain enamel, powdercoated post

	24"	12"	
12"	<p>The San Antonio T is a permanent outdoor cultural site with public art installations that connect viewers with a sense of time and place in this historic and rapidly growing U.S. city.</p> <p>San Antonio T es un sitio cultural permanente al aire libre con instalaciones de arte público que conectan a los televidentes con una sensación de tiempo y lugar en esta ciudad histórica y de rápido crecimiento en los Estados Unidos.</p>		<p><b>JUAN O'GORMAN</b> The Confluence of Civilizations in the Americas, 1968. Glass Mural Commissioned by Public Art San Antonio. Additional support is provided by City of San Antonio</p> <p>El mural, <i>Confluence of Civilizations in the Americas</i>, was created by Juan O'Gorman as part of the 1968 HemisFair (the World's Fair). The mural symbolizes the progress made by the confluence of civilizations in the Western Hemisphere. Adam and Eve are in the middle; European civilization is depicted on the right, and indigenous meso-American civilization on the left. To create the <i>Confluence of Civilizations in the Americas</i> mural commissioned for the 1968 World's Fair in San Antonio, Texas, Juan O'Gorman collected natural stones from all Mexico—twelve colors in all—field stones that the artist knew would never fade or change their hue.</p> <p><b>JUAN O'GORMAN</b> La confluencia de las civilizaciones en las Américas, 1968. Mural de vidrio Confluencia of Civilizations in the Americas está encargado por Public Art San Antonio. La Ciudad de San Antonio brinda apoyo adicional.</p> <p>El mural, <i>Confluence of Civilizations in the Americas</i>, fue creado por Juan O'Gorman como parte del HemisFair de 1968 (la Feria Mundial). El mural simboliza el progreso realizado por la confluencia de civilizaciones en el Hemisferio Occidental. Adán y Eva están en el medio; La civilización europea está representada a la derecha y la civilización indígena mesoamericana a la izquierda. Para crear el mural <i>Confluence of Civilizations in the Americas</i> encargado para la Feria Mundial de 1968 en San Antonio, Texas, Juan O'Gorman recolectó piedras naturales de todo México: doce colores en piedras de todo el terreno que el artista sabía que nunca se desvanecería ni cambiaría su tono.</p>
	24"	12"	<p><b>JUAN O'GORMAN</b> The Confluence of Civilizations in the Americas, 1968. Glass Mural Commissioned by Public Art San Antonio. Additional support is provided by City of San Antonio</p> <p>The mural, <i>Confluence of Civilizations in the Americas</i>, was created by Juan O'Gorman as part of the 1968 HemisFair (the World's Fair). The mural symbolizes the progress made by the confluence of civilizations in the Western Hemisphere. Adam and Eve are in the middle; European civilization is depicted on the right, and indigenous meso-American civilization on the left. To create the <i>Confluence of Civilizations in the Americas</i> mural commissioned for the 1968 World's Fair in San Antonio, Texas, Juan O'Gorman collected natural stones from all Mexico—twelve colors in all—field stones that the artist knew would never fade or change their hue.</p> <p><b>JUAN O'GORMAN</b> La confluencia de las civilizaciones en las Américas, 1968. Mural de vidrio Confluencia of Civilizations in the Americas está encargado por Public Art San Antonio. La Ciudad de San Antonio brinda apoyo adicional.</p> <p>El mural, <i>Confluence of Civilizations in the Americas</i>, fue creado por Juan O'Gorman como parte del HemisFair de 1968 (la Feria Mundial). El mural simboliza el progreso realizado por la confluencia de civilizaciones en el Hemisferio Occidental. Adán y Eva están en el medio; La civilización europea está representada a la derecha y la civilización indígena mesoamericana a la izquierda. Para crear el mural <i>Confluence of Civilizations in the Americas</i> encargado para la Feria Mundial de 1968 en San Antonio, Texas, Juan O'Gorman recolectó piedras naturales de todo México: doce colores en piedras de todo el terreno que el artista sabía que nunca se desvanecería ni cambiaría su tono.</p>

When temporary artworks are moved from the River Walk Public Art Garden to their permanent home, the label moves along with it.

Artwork labels are designed to be part of a system which mount to various wall types or stake into the ground.

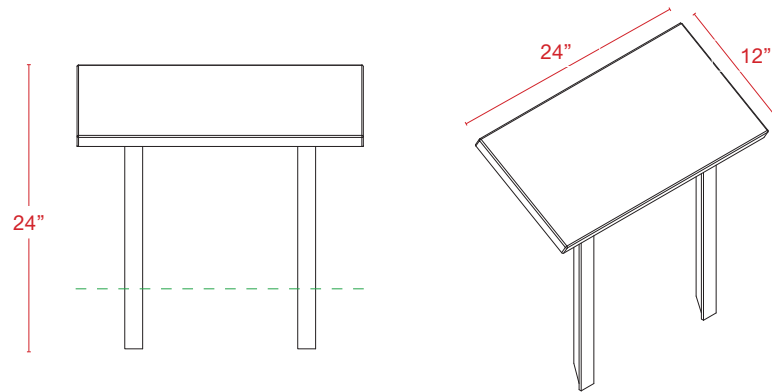

Signage: Permanent



*Pedro Reyes Flag*, Peak's Park  
Printed nylon flag, mirror / chrome  
finish flagpole

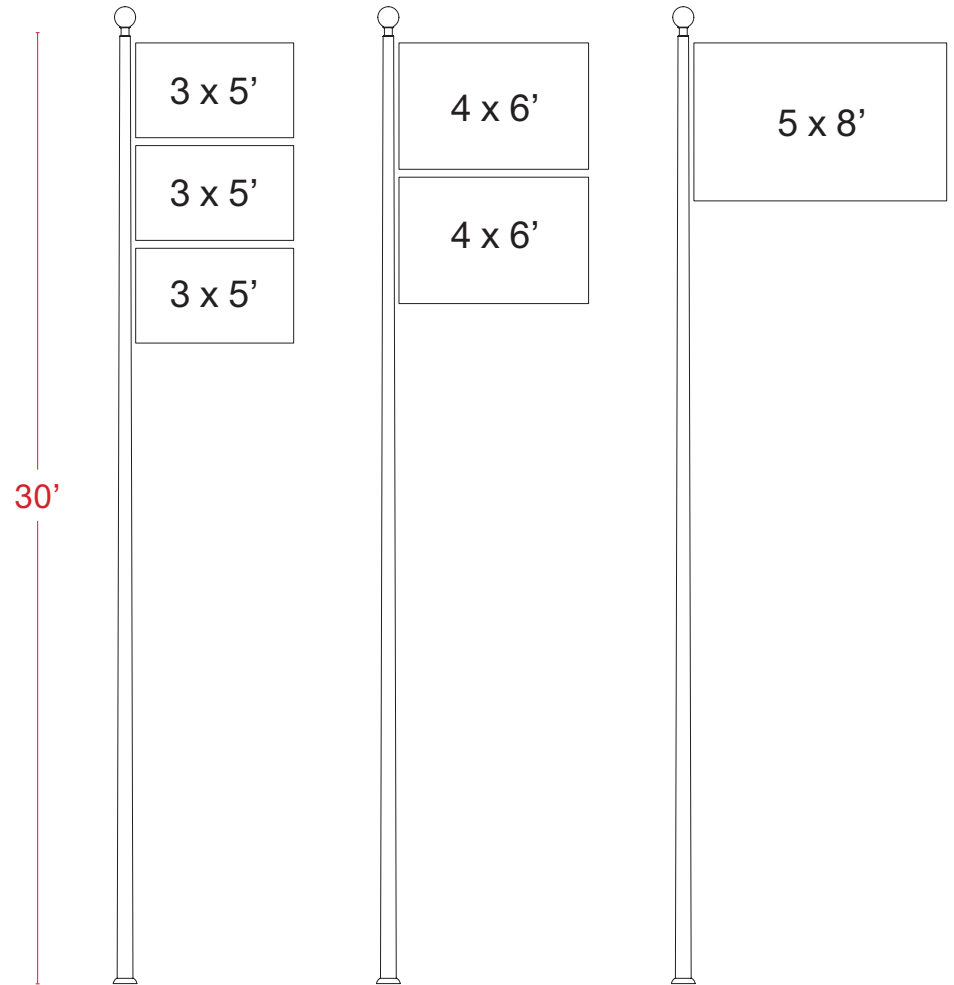

A flag system announces each artwork on view. Each artist will be asked to provide an image that introduces their work.

The flag size adapts to accommodate the number of artists announced on site.

Signage: Temporary

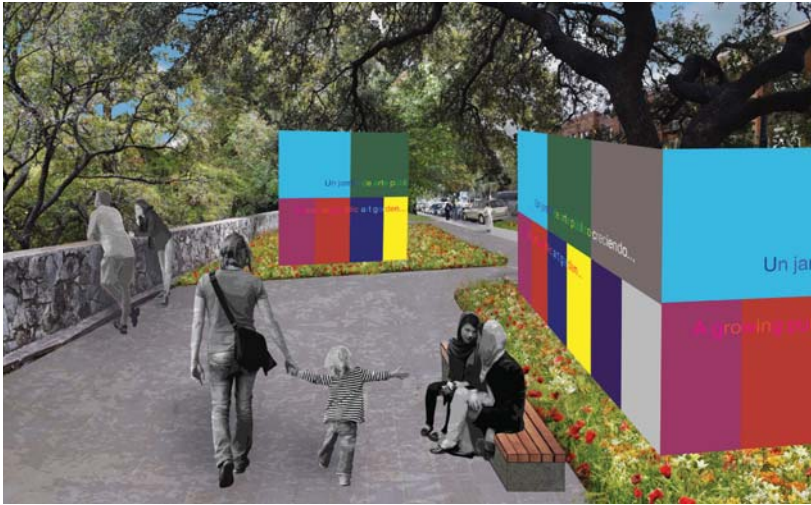

*Under construction Tarp, locations TBD*

Signage: Precedents



Mesh Banners from Signs of San Antonio, Dylan Kraus mesh banner artwork on construction scaffold, and laser cut vinyl by Ai Weiwei



High Line Graphics and Standard Concealed Frame System (CFS) in porcelain enamel, both produced by Winsor Fireform

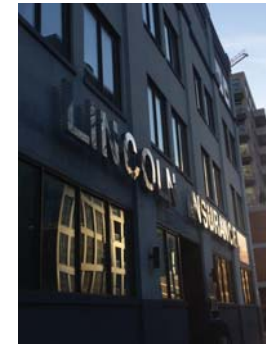

Barrier wall signage, reflective surfaces, and mounting techniques